

TRIG TY91/TY92 (TC90) - Adapter BLE Bluetooth

vfrNav EXPERIMENTAL

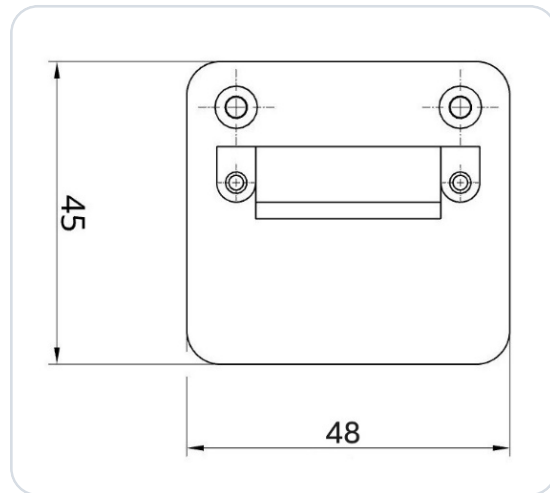

Bluetooth Low Energy adapter (BLE) for a TRIG TY91/92 VHF transceiver (aviation radio).

The adapter was developed as an interface between a TRIG TY91/92 and the navigation software vfrNav. It realizes the data transfer between the navigation software (SD) and the hardware of the TC90 control head of the radio (BLE ↔ RS-232). The adapter simply plugs into the existing wiring to the TC90 control head and is held securely to the housing by two knurled screws.

No additional power supply is necessary. The adapter can be operated with 12 V and 24 V aircraft voltage. An internal mini-fuse (125 mA) is integrated in the housing.

The power supply is protected against reverse polarity and short-circuit proof.

A control unit already connected to the TC90 (EFIS, Garmin G3X, etc.) remains functional.

No further electrical or mechanical work required!

IMPORTANT

This is a prototype for experimental use only!

1 Radio Configuration

No further configuration is required on the radio.

2 Firmware Requirements

The adapter works from firmware 1.5 of the TC90 control head onwards.



The current firmware version appears briefly after power-on. It should show at least **Controller v 1.5**.

3 Connector Pin Assignment

This is an excerpt from the TRIG installation manual:

PIN	SIGNAL	DIRECTION
1	Ground	–
2	TMAPA	Bidirectional
3	TMAPB	Bidirectional
4	Ground	–
5	RS232 Tx	Output
6	RS232 Rx	Input
7	Ground	–
8	Remote ON	Output
9	Power IN	Input
10	Power Ground	–
11	Reserved	–
12	Step Button	Input
13	Transfer Button	Input
14	Reserved	–
15	Reserved	–

Source: TRIG TY91/TY92 installation manual.

4 Configuration in vfrNav

IMPORTANT

Do not pair the SD-Link in the Bluetooth settings

The SD-Link adapter is a Bluetooth Low Energy (BLE) device. BLE devices are not paired via the Bluetooth settings of your tablet or phone like regular Bluetooth devices such as headsets or speakers.

Therefore, please do not open the Bluetooth settings of iOS, Android or Windows to search for or pair the SD-Link there.

The connection to the SD-Link is set up exclusively within the navigation app itself, e.g. in SkyDemon, Sky-Map, VFRnav, EasyVFR or another supported app. Pairing at operating-system level is not required and can even prevent the connection.

Regular Bluetooth devices such as headsets, intercoms or speakers can still be used in parallel. They are paired via the operating system as usual. The SD-Link, however, is addressed directly by the navigation app.

If the SD-Link has already been paired in the Bluetooth settings: Please remove the SD-Link completely from the Bluetooth device list of your tablet or phone. Do not pair it again via the operating system afterwards; instead, set it up again exclusively within the navigation app.

REMEMBER

**Do not pair the SD-Link in the operating system.
Always set up the SD-Link directly in the navigation app.**



- Switch on aircraft power, turn on the radio.
- Enable Bluetooth on your phone/tablet.
- Start vfrNav.
 - ① Open menu
 - ② Open settings menu
 - ③ Under Device connections → Radio
 - ④ Select interface

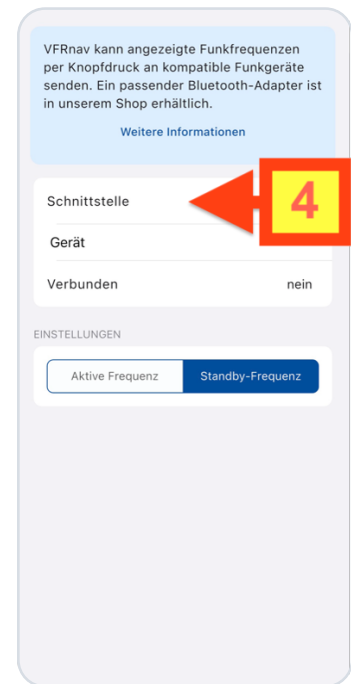
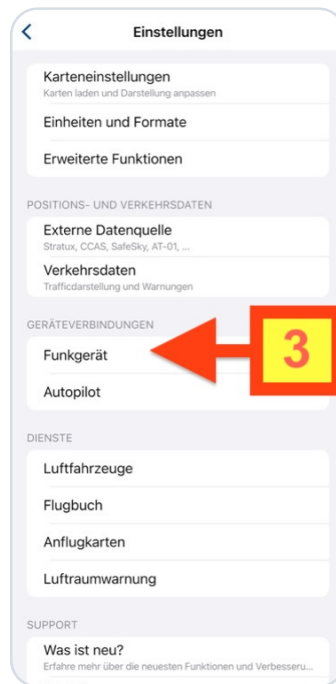
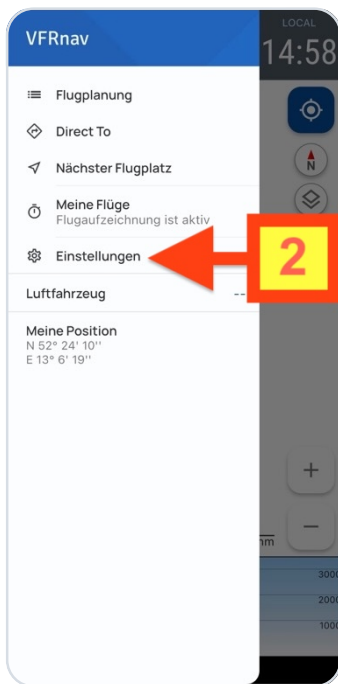

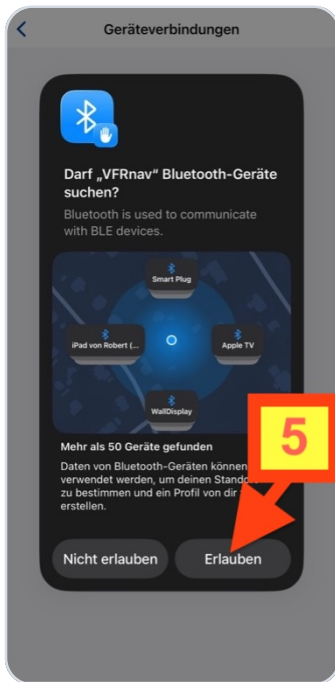

- ⑤ Enable Bluetooth if necessary
- ⑥ Select the name of the found adapter: **SD-TYX**
- ⑦ If the protocol was not automatically detected, please adjust it under „Gerät" anpassen.
- ⑧ In the connection settings, specify whether the frequency should be transmitted to the radio immediately as active or as standby.

IMPORTANT NOTICE

Check under „Verbunden": It should say „ja" stehen.

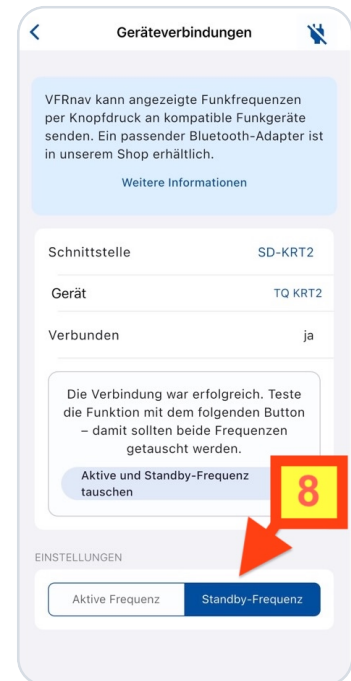
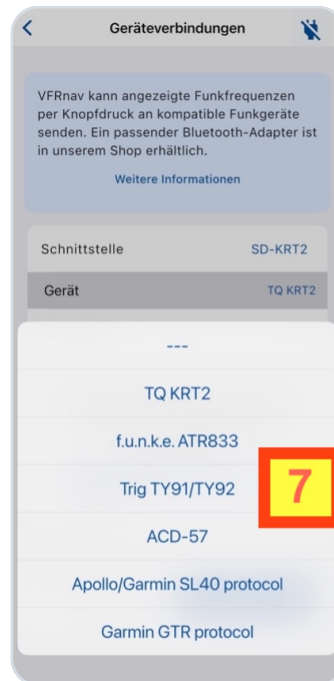
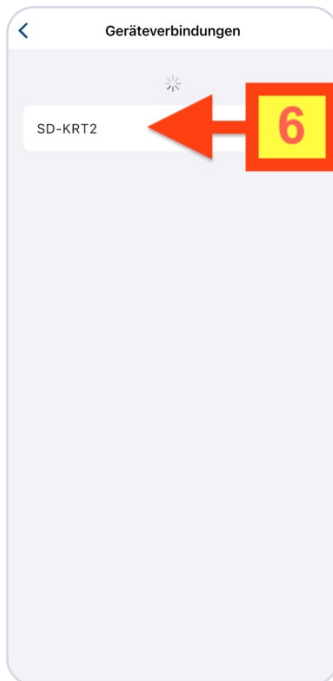

5 Contact

If you have any questions, problems or feedback, please contact us:

LayCom Vision GmbH – SD-Link

Michael Hoffmann

Chausseestr. 46
D-15518 Rauen, Germany

E-Mail info@sdlink.de

Phone [+49 3361 710253](tel:+493361710253)

Web www.sdlink.de

