

# f.u.n.k.e ATR833 - BLE Bluetooth Dual Source Adapter

## SkyDemon (SD) EXPERIMENTAL

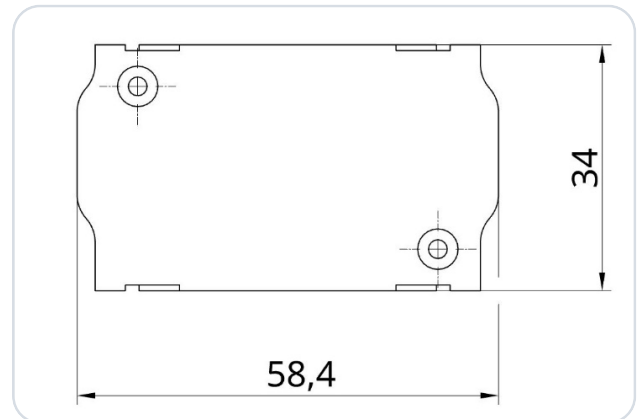

The Bluetooth Low Energy adapter (BLE) for a f.u.n.k.e ATR833 VHF transceiver (aviation radio) is compatible with the following devices: **ATR833, ATR833S, ATR833A, ATR833-II, ATR833A-II.**

The adapter was originally developed for connection to the SkyDemon navigation software, but is now compatible with a variety of navigation apps that support frequency transmission. It implements the data transfer between the navigation software and the radio hardware (BLE ↔ RS-232). The adapter simply plugs in between the existing wiring and the radio and is securely held in place on the housing thanks to the Molex Spring Lock system.

No additional power supply is required. The adapter can be operated with 12 V and 24 V onboard voltage. An internal, self-resetting fuse is integrated in the housing. The power supply is protected against reverse polarity and short-circuit proof.

**The adapter also works when an EFIS is already connected to the radio.**

**No additional electrical or mechanical work required!**

### IMPORTANT

This is a prototype for experimental use only!

# 1 Radio Configuration

## IMPORTANT

Supported are ATR833-S, ATR833-A and ATR833-II-OLED from software SW 5.8. Older versions ( $\leq 5.7$ ) are not compatible. First supported serial number: 40131610 (2010). Tip: the last two digits of the serial number = year of production.

No further configuration is required on the radio.

# 2 Connector Pin Assignment

This is an excerpt from the f.u.n.k.e installation manual:

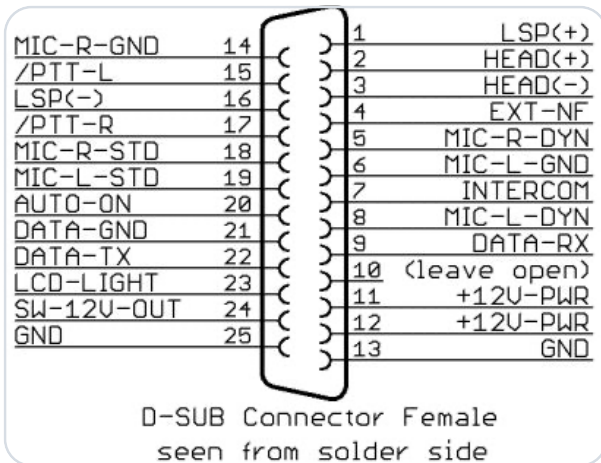

Figure 1 · Old version (ATR833)

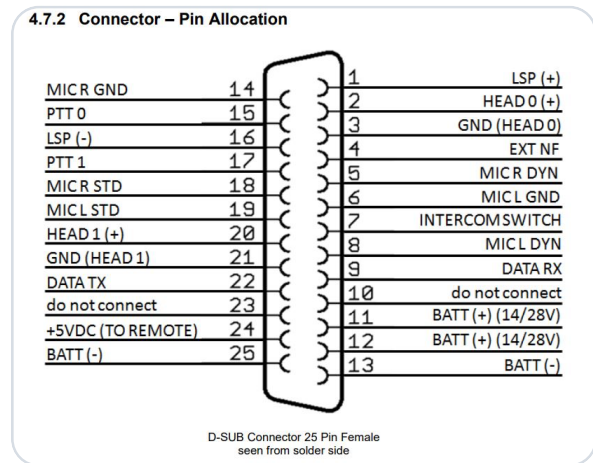

Figure 2 · New version (ATR833-II)

## D-SUB 25-Pin · Pin Allocation in Detail

D-SUB 25-pin female connector, solder side. Complete allocation according to the f.u.n.k.e manual.

PIN	NAME	FUNCTION
1	LSP (+)	Output external Loudspeaker Positive
2	HEAD-0 (+)	Output Headset-Speaker Positive
3	GND (HEAD-0)	Output Headset-Speaker Negative
4	EXT-NF	Input external Audio-Signal
5	MIC R DYN	Input Microphone Right Dynamic
6	MIC L GND	Input Microphone Left Ground
7	INTERCOM SWITCH	Intercom Activation Switch (connect to ground for Intercom activation)
8	MIC L DYN	Input Microphone Left Dynamic
9	DATA-RX	RS232 Receive (for Remote Control)
10	do not connect	Pin 10 is used by adapters for device identification
11	+14 / +28V-PWR	Input Power Supply +12V
12	+14 / +28V-PWR	Input Power Supply +12V
13	BATT (-)	Ground Side of Power Supply
14	MIC R GND	Input Microphone Right Ground
15	PTT-0	Push-to-Talk 0 (connect to ground for transmitting)
16	LSP (-)	Output external Loudspeaker Negative (Not identical to ground!)
17	PTT-1	Push-to-Talk 1 (connect to ground for transmitting)
18	MIC R STD	Input Microphone Right (Headset 1)
19	MIC L STD	Input Microphone Left (Headset 0)
20	HEAD 1 (+)	Output 1 Headset-Speaker Positive
21	GND (HEAD 1)	Output 1 Headset-Speaker Negative
22	DATA-TX	RS232 TX (for Remote Control)
23	N/A	do not connect
24	+5VDC OUT	5VDC Power Supply for Remote Control
25	BATT (-)	Ground Side of Power Supply

Source: f.u.n.k.e manual.

### 3 Configuration in SkyDemon

#### IMPORTANT

##### Do not pair the SD-Link in the Bluetooth settings

The SD-Link adapter is a Bluetooth Low Energy (BLE) device. BLE devices are not paired via the Bluetooth settings of your tablet or phone like regular Bluetooth devices such as headsets or speakers.

Therefore, please do not open the Bluetooth settings of iOS, Android or Windows to search for or pair the SD-Link there.

The connection to the SD-Link is set up exclusively within the navigation app itself, e.g. in SkyDemon, Sky-Map, VFRnav, EasyVFR or another supported app. Pairing at operating-system level is not required and can even prevent the connection.

Regular Bluetooth devices such as headsets, intercoms or speakers can still be used in parallel. They are paired via the operating system as usual. The SD-Link, however, is addressed directly by the navigation app.

**If the SD-Link has already been paired in the Bluetooth settings:** Please remove the SD-Link completely from the Bluetooth device list of your tablet or phone. Do not pair it again via the operating system afterwards; instead, set it up again exclusively within the navigation app.

#### REMEMBER

**Do not pair the SD-Link in the operating system.**

**Always set up the SD-Link directly in the navigation app.**

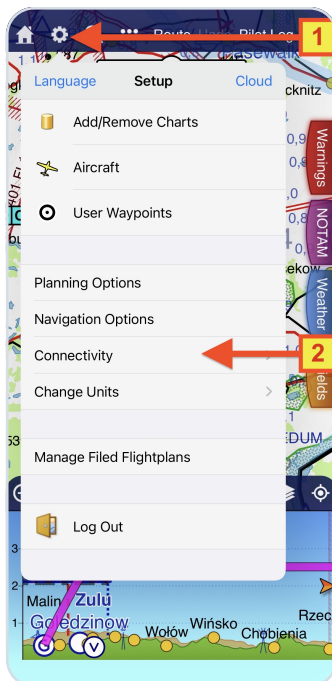

- ① Open the configuration menu via the gear icon.
- ② Select **Wireless Devices** in the configuration.

- ③ In Wireless Devices → select Add Bluetooth Device.

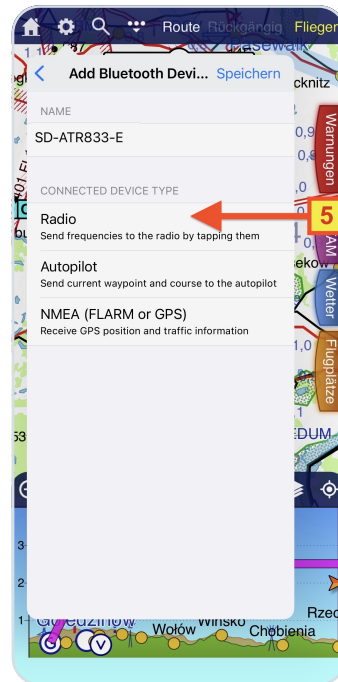
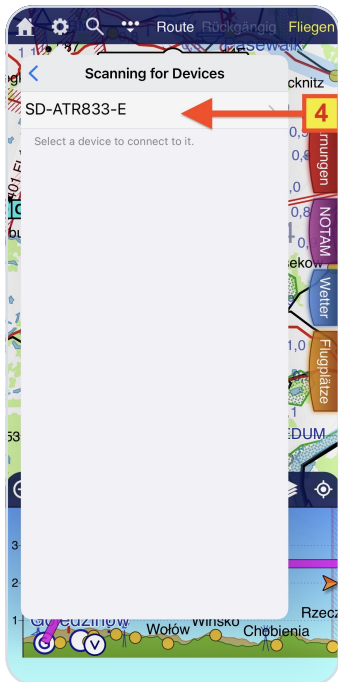
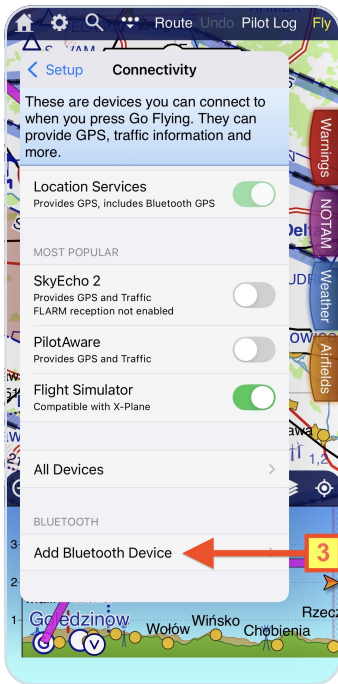

- ④ Wait until the search for BLE devices is complete (this may take a moment). Then select the entry **SD-ATR833-DS**
- ⑤ Select the device type **Radio**.

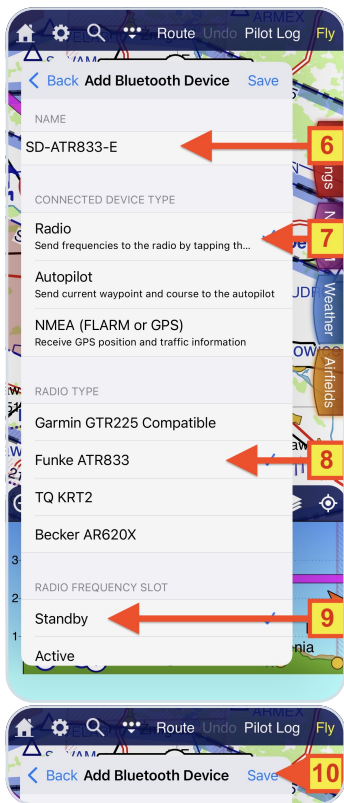

- ⑥ The adapter name can be customized as desired.
- ⑦ The device type **Radio** must be selected.
- ⑧ Select the radio type **Funke ATR833**.
- ⑨ Choose whether to set the standby or active frequency.
- ⑩ **Save the settings with Save** - the adapter is now ready for use.

## 4 Contact

For problems, questions, feedback, or positive responses, please contact:

### LayCom Vision GmbH – SD-Link

Michael Hoffmann

Chausseestr. 46  
D-15518 Rauen, Germany

E-Mail [info@sdlink.de](mailto:info@sdlink.de)

Phone **+49 3361 710253**

Web [www.sdlink.de](http://www.sdlink.de)

