

Becker AR6201 (AR620X) – BLE Bluetooth Adapter (Plug and Play)

vfrNav EXPERIMENTAL

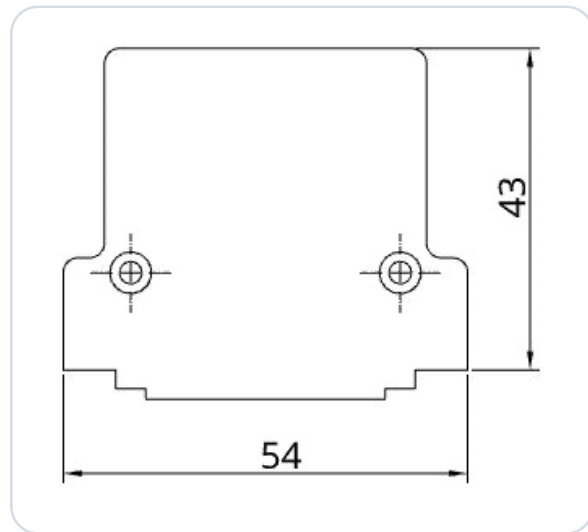

Bluetooth Low Energy adapter (BLE) for a Becker AR6201 / AR6203 / RT6201 VHF transceiver (aviation radio) AR620X.

The adapter was developed as an interface between a Becker AR6201 and the navigation software vfrNav. It implements the data transfer between the navigation software (vfrNav) and the radio hardware (BLE ↔ RS-232 ↔ RS-422). The adapter simply plugs onto the free port J1 and is held securely to the housing thanks to the Conec SlideLock system.

No additional power supply from the aircraft electrical system is necessary.

No further mechanical work required!

IMPORTANT

This is a prototype for experimental use only!!!

1 Radio Configuration

IMPORTANT

The prerequisite for using the BLE adapter is a serial number of the Becker AR620X (AR SN) from 3001 onwards.

The Becker AR6201 must be operated in **tandem mode** to use the BLE adapter.

The following configuration steps are necessary:

2.7.1. Start des Konfigurationssetups

<div style="border: 1px solid #ccc; padding: 5px; text-align: center;"> <p>PASSWORD</p> <p style="font-size: 24px; margin: 0;">6435</p> </div> <p style="text-align: center; font-size: 10px;">Abbildung 2-17: "PASSWORD"</p>	<ul style="list-style-type: none"> Halten Sie die "MDE"-Taste während des Einschaltens gedrückt, um in das Menü des Konfigurationssetups zu gelangen. Die Anzeige "PASSWORD" erscheint. 						
<div style="border: 1px solid #ccc; padding: 5px;"> <p>DEVICE INFO</p> <table style="width: 100%; border-collapse: collapse; font-size: 8px;"> <tr> <td style="border-bottom: 1px solid #ccc;">CM SW VER</td> <td style="text-align: right;">2.06</td> </tr> <tr> <td style="border-bottom: 1px solid #ccc;">CH SW VER</td> <td style="text-align: right;">4.06</td> </tr> <tr> <td>AR SN</td> <td style="text-align: right; border: 1px solid red;">03665</td> </tr> </table> </div> <p style="text-align: center; font-size: 10px;">Abbildung 2-18: "DECIVE INFO"</p>	CM SW VER	2.06	CH SW VER	4.06	AR SN	03665	<ul style="list-style-type: none"> Geben Sie den 4-stelligen numerischen Code "6435" ein, indem Sie den Drehschalter drehen und drücken. Bestätigen Sie mit einem Druck auf die "STO"-Taste. Es erscheint die erste Seite des Konfigurationssetups mit der Anzeige "DEVICE INFO" (Geräteinformationen).
CM SW VER	2.06						
CH SW VER	4.06						
AR SN	03665						

2.7.2. Navigieren zwischen den Seiten

Das Konfigurationssetup besteht aus mehreren Seiten. Navigation innerhalb der Hauptseiten:

- BILD AB (nächste Seite): drücken Sie "↓/SCN" oder den Drehschalter.
- BILD AUF (vorherige Seite): drücken Sie die Taste "IC/SQL".

Zur Navigation innerhalb der Unterseiten des Konfigurationssetups benutzen Sie den Drehschalter.

2.7.3. Konfigurationssetup - Daten speichern

Die eingestellten Werte für jeden Parameter werden sofort nach dem Wechsel zum nächsten Parameter abgespeichert.

Figure 1 · Extract from the Becker installation manual

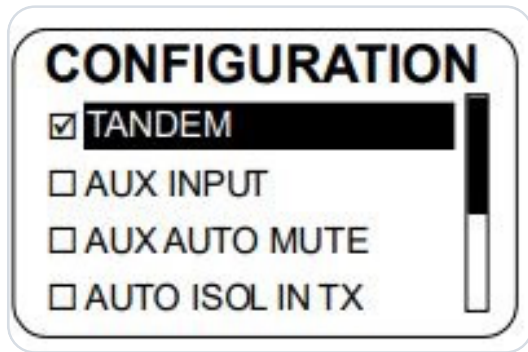

← Activate TANDEM!

2 Connector Pinout

This is an extract from the Becker installation manual:

Connector P1 (system interface)

PIN NR.	NAME	IN/OUT	FUNCTION
P1-1	SPK_HI	OUT	Ausgangssignal Lautsprecher
P1-2	HDPH1_A	OUT	Symmetrischer Ausgang für Kopfhörer 1
P1-3	HDPH1_B	OUT	Symmetrischer Ausgang für Kopfhörer 1
P1-4	AF_AUX_IN_HI	IN	AF-Zusatzgeräteeingang
P1-5	MIKE_DYN_HI	IN	Symmetrischer Eingang für dynamisches Mikrofon
P1-6	MIKE_DYN_LO	IN	Symmetrischer Eingang für dynamisches Mikrofon
P1-7	/IC	IN	Eingang für Intercom-Taste Status ACTIVE – Kontakt an GND geschlossen
P1-8	MIKE_STD_LO	–	Standardmikrofon(e) Low (Masse) verwendet für STD1, STD2 und STD3
P1-9	MIKE_STD2_HI	IN	Standardmikrofon 2 High
P1-10	ILL_LO	IN	Beleuchtung Low Eingang
P1-11	P_SUPP	IN	Versorgungsspannung (positiv)
P1-12	P_SUPP	IN	Versorgungsspannung (positiv)
P1-13	P_SUPP_GND	–	Versorgungsspannung Masse
P1-14	SPK_LO	–	Lautsprecher Masse
P1-15	LINE_OUT	OUT	Linearer Audioausgang, asymmetrisch
P1-16	AGC_OUT	OUT	Empfänger AGC-Ausgang
P1-17	/PTT1	IN	Sendetaste Eingang 1 Status ACTIVE – Kontakt an GND geschlossen
P1-18	MIKE_STD1_HI	IN	Standardmikrofon 1 High
P1-19	MIKE_STD3_HI	IN	Standardmikrofon 3 High
P1-20	HDPH2_A	OUT	Symmetrischer Ausgang für Kopfhörer 2
P1-21	AF_AUX_IN_LO	IN	AF-Zusatzgeräteeingang Low
P1-22	HDPH2_B	OUT	Symmetrischer Ausgang für Kopfhörer 2
P1-23	ILL_HI	IN	Beleuchtung High
P1-24	/PWR_EVAL	OUT	Einschalt-Überwachungsausgang
P1-25	P_SUPP_GND	–	Versorgungsspannung Masse

Source: Becker manual.

Connector J1 (serial interface and discrete I/Os)

PIN NR.	NAME	IN/OUT	FUNCTION
J1-1	CPIN	–	Kodier-Pin
J1-2	TX2+	OUT	Zusatzgeräte-Steuerschnittstelle
J1-3	RX2+	IN	Zusatzgeräte-Steuerschnittstelle
J1-4	/SQL_EVAL	OUT	Rauschsperrren-Überwachungsausgang Status ACTIVE – Kontakt an GND geschlossen
J1-5	/PTT2	IN	Sendetaste Eingang 2 Status ACTIVE – Kontakt an GND geschlossen
J1-6	SHIELD_1	–	Zweite Steuer- & Bedienschnittstelle SHIELD
J1-7	TX1+	OUT	Zweite Steuer- & Bedienschnittstelle
J1-8	RX1+	IN	Zweite Steuer- & Bedienschnittstelle
J1-9	TX2-	OUT	Zusatzgeräte-Steuerschnittstelle
J1-10	RX2-	IN	Zusatzgeräte-Steuerschnittstelle
J1-11	SHIELD_2	–	Zusatzgeräte-Steuerschnittstelle SHIELD
J1-12	/EXT_S0	IN	Externe “Exchange”-Taste Fallende Flanke aktiviert Frequenzwechsel
J1-13	/SRV_EN	IN	Einschalten des Wartungsbetriebes Status ACTIVE – Kontakt an GND geschlossen
J1-14	TX1-	OUT	Zweite Steuer- & Bedienschnittstelle
J1-15	RX1-	IN	Zweite Steuer- & Bedienschnittstelle
J1-16	NC	–	nicht angeschlossen
J1-17	/SQL_SW	IN	Eingang “Rauschsperrren-Zwangsabschaltung” Status ACTIVE – Kontakt an GND geschlossen
J1-18	NC	–	nicht angeschlossen
J1-19	NC	–	nicht angeschlossen
J1-20	/ISOL	IN	Eingang “ISOL” Status ACTIVE – Kontakt an GND geschlossen
J1-21	D_GND	–	Diskrete Leitungen Masse
J1-22	D_GND	–	Diskrete Leitungen Masse
J1-23	D_GND	–	Diskrete Leitungen Masse
J1-24	/MIKE_SW	IN	Konfigurationsselektor CFG1 und CFG2
J1-25	/EXT_ON	IN	Eingang “Externes Einschalten” Status ACTIVE – Kontakt an GND geschlossen

Source: Becker manual.

3 Configuration in vfrNav

IMPORTANT

Do not pair the SD-Link in the Bluetooth settings

The SD-Link adapter is a Bluetooth Low Energy (BLE) device. BLE devices are not paired via the Bluetooth settings of your tablet or phone like regular Bluetooth devices such as headsets or speakers.

Therefore, please do not open the Bluetooth settings of iOS, Android or Windows to search for or pair the SD-Link there.

The connection to the SD-Link is set up exclusively within the navigation app itself, e.g. in SkyDemon, Sky-Map, VFRnav, EasyVFR or another supported app. Pairing at operating-system level is not required and can even prevent the connection.

Regular Bluetooth devices such as headsets, intercoms or speakers can still be used in parallel. They are paired via the operating system as usual. The SD-Link, however, is addressed directly by the navigation app.

If the SD-Link has already been paired in the Bluetooth settings: Please remove the SD-Link completely from the Bluetooth device list of your tablet or phone. Do not pair it again via the operating system afterwards; instead, set it up again exclusively within the navigation app.

REMEMBER

**Do not pair the SD-Link in the operating system.
Always set up the SD-Link directly in the navigation app.**



- Switch on aircraft power, turn on the radio.
- Enable Bluetooth on your phone/tablet.
- Start vfrNav.
 - ① Open menu
 - ② Open settings menu
 - ③ Under Device connections → Radio
 - ④ Select interface

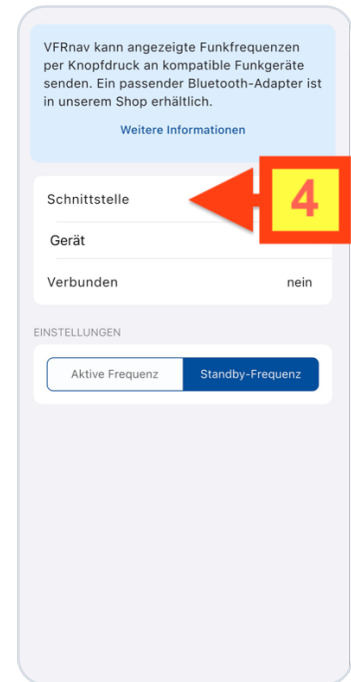
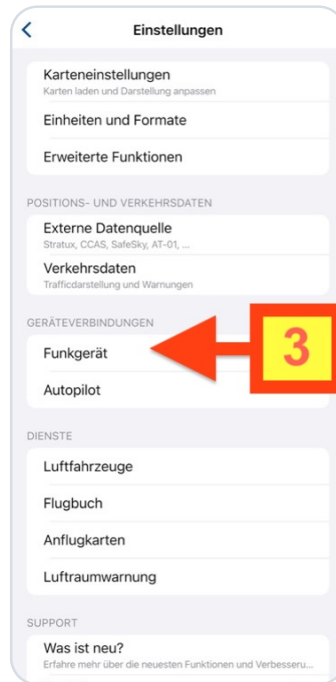
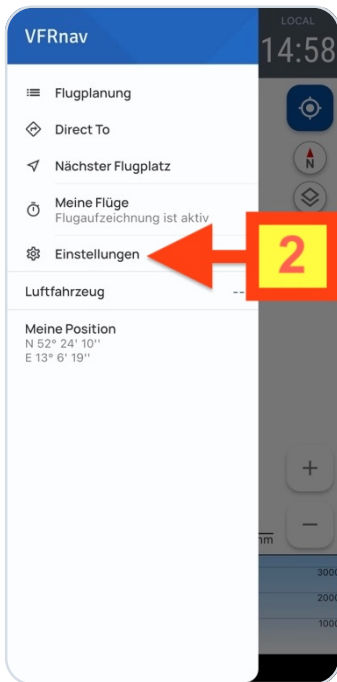

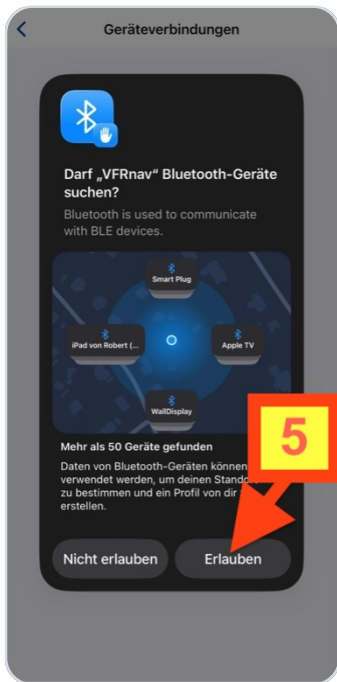

- ⑤ Enable Bluetooth if necessary
- ⑥ Select the name of the found adapter. For example "SD-ATR833", "SD-KRT2", "SD-TYX", etc.
- ⑦ If the protocol was not automatically detected, please adjust it under "Device".
- ⑧ In the connection settings, specify whether the frequency should be transmitted to the radio immediately as active or as standby.

IMPORTANT NOTICE

Check under "Connected": It should say "yes".

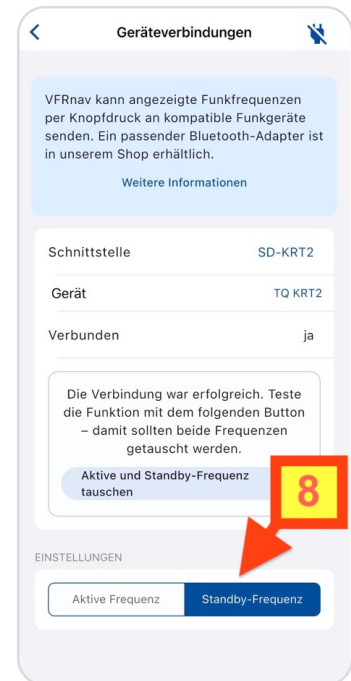
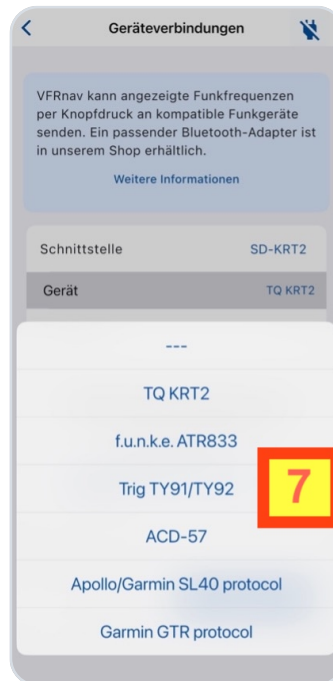
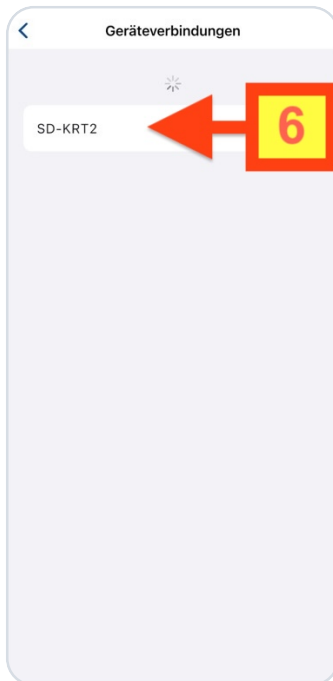

4 Contact

For problems, questions, suggestions or positive feedback, please contact:

LayCom Vision GmbH – SD-Link

Michael Hoffmann

Chausseestr. 46
D-15518 Rauen, Germany

E-Mail info@sdlink.de

Phone **+49 3361 710253**

Web www.sdlink.de



Dimensions

